

## Ceiling mounted adjustable spotlights

Ceiling mounted LED display luminaires with integral control gear. 300° azimuth and 180° vertical adjustment. 20 W, 28 W or 35 W – 17°, 28° or 41° beam versions. (Formerly named Hi-Liter)

Applications: office, retail, reception areas, restaurants, hospitality areas, arenas.

- 17°, 28° and 41° beam angle versions
- 355° azimuth adjustment
- 180° vertical adjustment
- Integral electronic control gear
- Can be supplied pre-wired with a purpose made 1 m connection lead for plugging directly into the Smart Hub
- Fitted with CRI 90 LEDs with enhanced R9 value. Suitable for retail applications
- Suitable for ceiling mount only

Notes: Black and silver finishes or CRI 80 versions available to special order (minimum order quantity applies)



IP20

Up to 97.3 LL/CW

### Specification

Mounting	Surface	IP rating	IP20
----------	---------	-----------	------

### Lighting

Lumen output	1,960 lm - 3,625 lm	Efficacy	Up to 97.3 LL/CW
--------------	---------------------	----------	------------------

### Power

LED power	20 W - 35 W	Circuit power	24 W - 41 W
-----------	-------------	---------------	-------------

### LED characteristics

CRI	90+	Colour temperature	3000 K 4000 K
Rated life (hours)	50 K - L70/B10		

### Compliance

UKCA	Yes	CE	Yes
------	-----	----	-----

## Dimensions

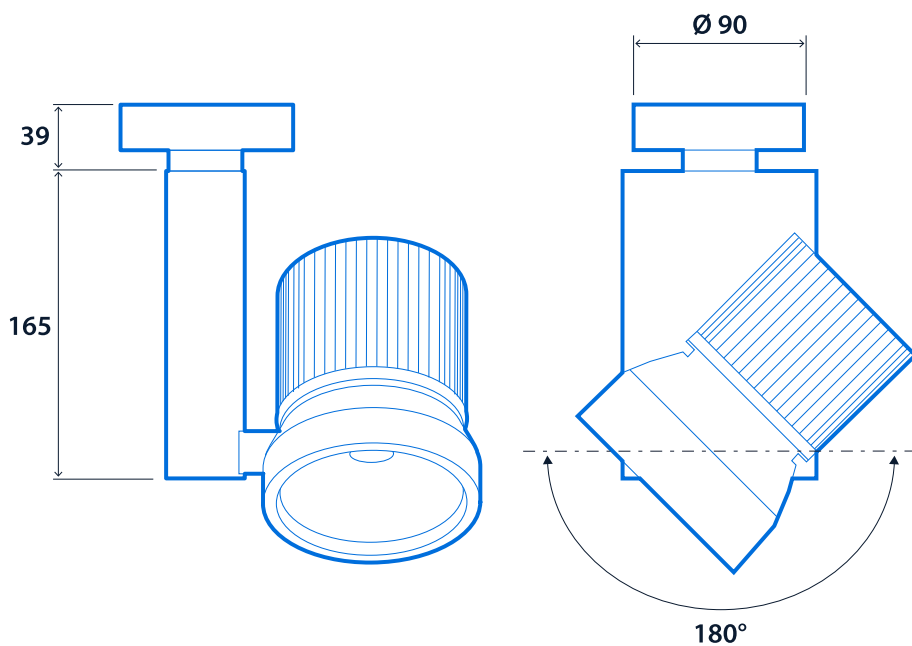

**Click or scan here**  
View Zenith-L variants using  
our online filtering tool

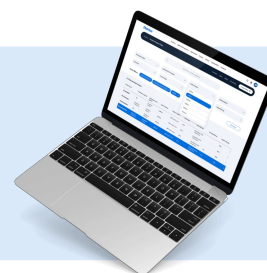

Information is correct as of 22-Jan-2025, however must not be interpreted as a guarantee of individual product performance and/or characteristics. We reserve the right to alter specifications and designs without prior notice.